

JOYLU[®]
JOYLU SPORT



**CATÁLOGO
STOCK**

2023

CATÁLOGO ONLINE

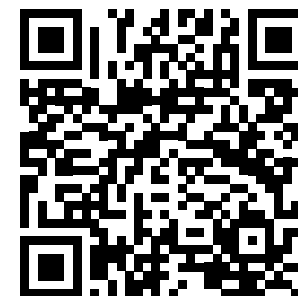

PERSONALIZA

Ante la demanda cada vez mayor por el público en general de artículos fabricados en exclusiva para algún tipo de celebración deportiva, evento, etc... les ofrecemos el servicio de fabricación a medida

El tiempo de servicio oscila entre los 7 y 15 días dependiendo de la complejidad del modelo

La cantidad mínima de fabricación es de 50 prendas por modelo, siendo por talla múltiplo de 10



JOYLU[®]

JOYLU SPORT

PUEDE REALIZAR
SU CONFIGURACIÓN EN
“DISEÑA TU PRENDA”

DENTRO DE NUESTRA WEB

www.joylu.com

ELIGE LOS COLORES

en las prendas
que contengan
este sello



SUDADERA BÁSICA BASIC Ref. 109



DESCRIPCIÓN

Sudadera de corte clásico de cuello redondo, con doble pespunte en cuello.

TEJIDO

Felpa lisa perchada

COMPOSICIÓN

70% algodón 30% poliéster
260 gr/m²

OPCIONES DE PERSONALIZACIÓN

- Bordado
- Serigrafía
- Vinilo termoadhesivo

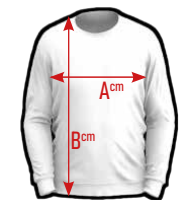

MEDIDAS APROXIMADAS



	XS	S	M	L	XL	XXL
A	49	53	57	61	65	69
B	65	71	74	77	80	83



4 UNISEX INVIERNO FELPA



Marino

01

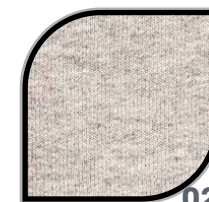

Gris

02

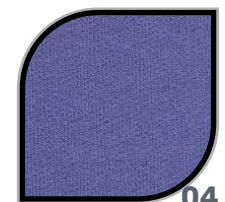

Devín

04



Negro

13



Náutico

15

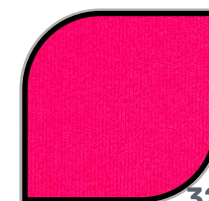

Fucsia

32

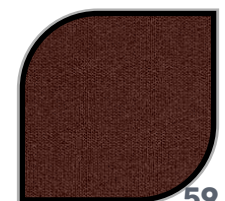

Chocolate

59



Marino

Gris

SUDADERA BÁSICA CÓRDOBA Ref. 001



Blanco

Rojo



Negro

Náutico

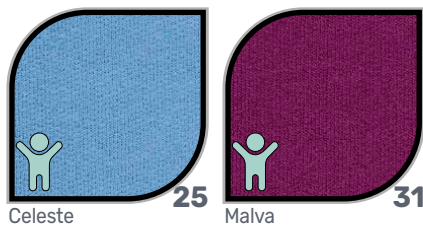

Celeste

Malva

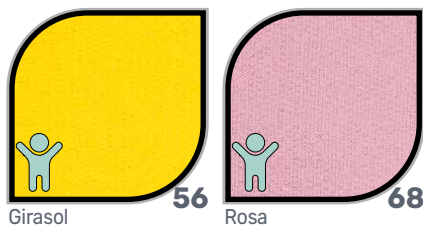

Girasol

Rosa

DESCRIPCIÓN

Sudadera de corte clásico de cuello redondo, con doble pespunte en cuello, puños y cintura.

TEJIDO

Felpa lisa perchada

COMPOSICIÓN

50% algodón 50% poliéster
285 gr/m²

OPCIONES DE PERSONALIZACIÓN

- Bordado
- Serigrafía
- Vinilo termoadhesivo



	2/3	4/5	6/7	8/9	10/11
A	33	36	39	42	45
B	42	46	50	54	58

	XS	S	M	L	XL	XXL	3XL
A	49	53	57	61	65	69	73
B	65	68	71	74	77	80	83

MEDIDAS APROXIMADAS

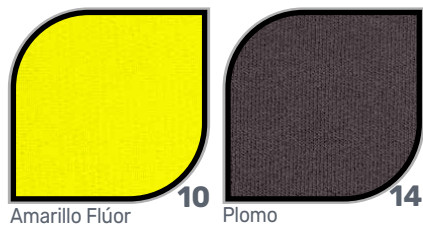
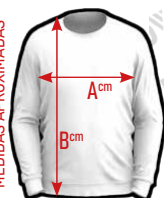

Amarillo Flúor

Plomo

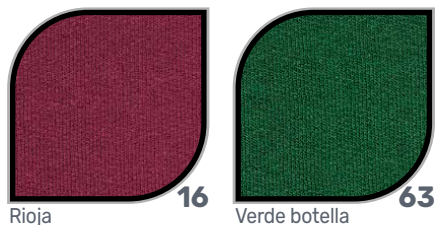

Rioja

Verde botella



SUDADERA BÁSICA SIN CANALÉ

Ref. 002



DESCRIPCIÓN

Sudadera de corte clásico cuello redondo, doble respunte en cuello. Cintura y puños sin canalé.

TEJIDO

Felpa lisa perchada

COMPOSICIÓN

50% algodón 50% poliéster
285 gr/m²

OPCIONES DE PERSONALIZACIÓN

- ▶ Bordado
- ▶ Serigrafía
- ▶ Vinilo termoadhesivo

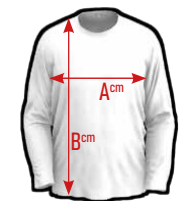

MEIDAS APROXIMADAS



	XS	S	M	L	XL	XXL
A	49	53	57	61	65	69
B	67	70	73	76	79	82



Marino

01



Gris

02



Blanco

03

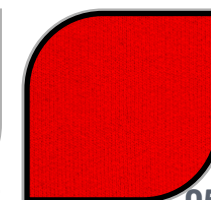

Rojo

05



Negro

13



SUDADERA BÁSICA MIAMI

Ref. 037



DESCRIPCIÓN

Sudadera de corte ranglan de cuello redondo, con doble pespunte en cuello, puños y cintura.

TEJIDO

Felpa lisa perchada

COMPOSICIÓN

50% algodón 50% poliéster
285 gr/m²

OPCIONES DE PERSONALIZACIÓN

- Bordado
- Serigrafía
- Vinilo termoadhesivo

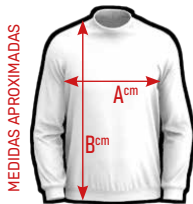

	XS	S	M	L	XL	XXL
A	49	53	57	61	65	69
B	65	68	71	74	77	80

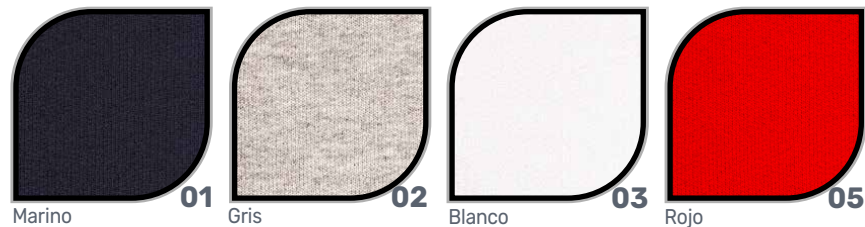

SUDADERA ORIGINAL ORLANDO

Ref. 040



DESCRIPCIÓN

Sudadera de corte ranglan de cuello alto con cremallera, con doble pespunte en puños y cintura.

TEJIDO

Felpa lisa perchada

COMPOSICIÓN

50% algodón 50% poliéster
285 gr/m²

OPCIONES DE PERSONALIZACIÓN

- ▶ Bordado
- ▶ Serigrafía
- ▶ Vinilo termoadhesivo

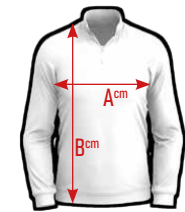

MEDIDAS APROXIMADAS

	XS	S	M	L	XL	XXL
A	49	53	57	61	65	69
B	65	68	71	74	77	80



Marino 01

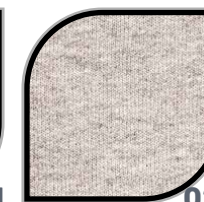

Gris 02

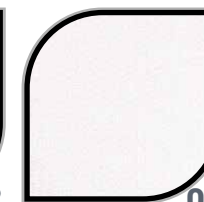

Blanco 03

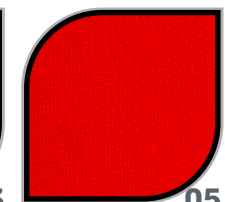

Rojo 05

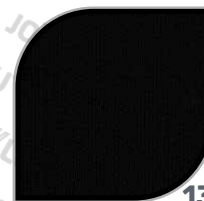

Negro 13



Rojo/Negro 39

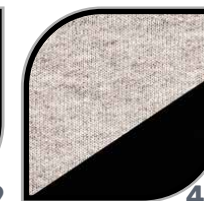

Gris/Negro 45

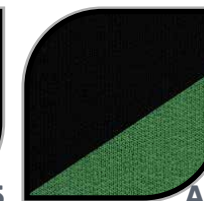

Negro/Billar AC



Marino/Rioja BF



SUDADERA ORIGINAL SEVILLA

Ref. 202



DESCRIPCIÓN

Sudadera corte clásico de cuello alto con cremallera, con doble pespunte en puños y cintura.

TEJIDO

Felpa lisa perchada

COMPOSICIÓN

50% algodón 50% poliéster
285 gr/m²

OPCIONES DE PERSONALIZACIÓN

- ▶ Bordado
- ▶ Serigrafía
- ▶ Vinilo termoadhesivo

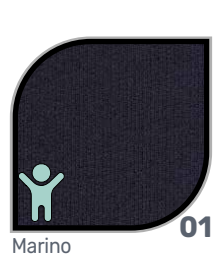

	6/7	8/9	10/11
A	39	42	45
B	50	54	58

	XS	S	M	L	XL	XXL
A	49	53	57	61	65	69
B	65	68	71	74	77	80

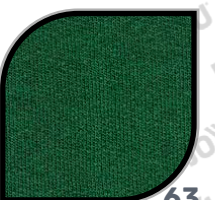
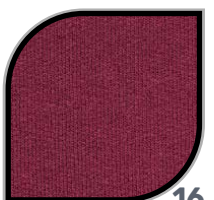
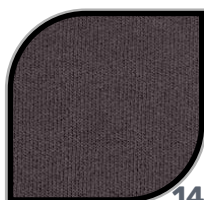
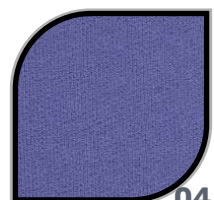
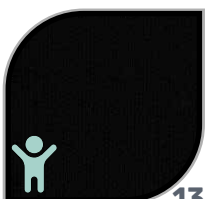

UNISEX INVIERNO FELPA

SUDADERA CAPUCHA BASIC

Ref. 115
BOLSILLO CANGURO



DESCRIPCIÓN

Sudadera corte clásico con capucha doble, bolsillo canguro a tono.

TEJIDO

Felpa lisa perchada

COMPOSICIÓN

70% algodón 30% poliéster
260 gr/m²

OPCIONES DE PERSONALIZACIÓN

- Bordado
- Serigrafía
- Vinilo termoadhesivo



	XS	S	M	L	XL	XXL
A	49	53	57	61	65	69
B	65	71	74	77	80	83

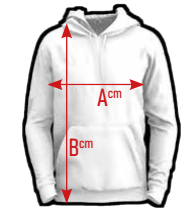

MEDIDAS APROXIMADAS



Marino

Gris

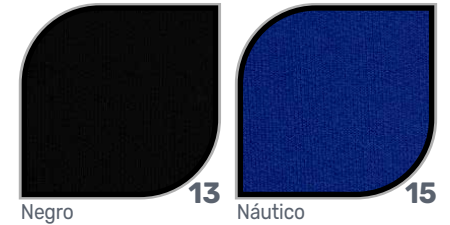

Negro

Náutico



Negro/Malva

Náutico/Girasol



Gris/Malva

Blanco/Náutico



Marino/Rojo

Rojo/Blanco

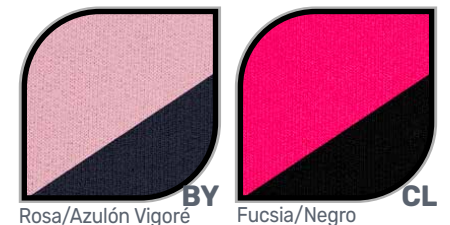

Rosa/Azulón Vigore

Fucsia/Negro



CREATU DISEÑO

FABRICADO EN
ESPAÑA
MADE IN
SPAIN

UNISEX INVIERNO FELPA

10 JOYLU



Blanco/Negro

09



Marino/Gris

22

SUDADERA CAPUCHA MADRID

Ref. 009

**BOLSILLO CANGURO****DESCRIPCIÓN**

Sudadera corte clásico con capucha doble, bolsillo canguro a tono, con doble pespunte en puños y cintura.

TEJIDO

Felpa lisa perchada

COMPOSICIÓN

50% algodón 50% poliéster
285 gr/m²

OPCIONES DE PERSONALIZACIÓN

- ▶ Bordado
- ▶ Serigrafía
- ▶ Vinilo termoadhesivo



Rojo/Negro

39



Gris/Negro

45



Negro/Gris

48



Rosa/Malva

49



Malva/Blanco

50

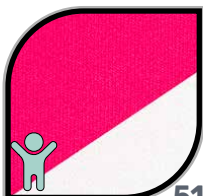

Fucsia/Blanco

51



Náutico/Blanco

55



Chocolate/Naranja

58



	6/7	8/9	10/11
A	39	42	45
B	52	54	58

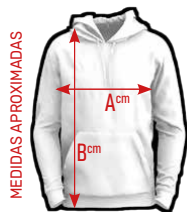

MEDIDAS APROXIMADAS

	XS	S	M	L	XL	XXL
A	49	53	57	61	65	69
B	65	68	71	74	77	80

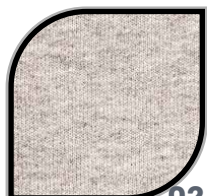

Gris

02



Negro

13



Celeste/Marino

82



UNISEX INVIERNO FELPA

JOYLU

SUDADERA CAPUCHA MURCIA Ref. 005



DESCRIPCIÓN

Sudadera corte clásico con capucha simple con doble pespunte en puños y cintura.

TEJIDO

Felpa lisa perchada

COMPOSICIÓN

50% algodón 50% poliéster
285 gr/m²

OPCIONES DE PERSONALIZACIÓN

- Bordado
- Serigrafía
- Vinilo termoadhesivo



MEDIDAS APROXIMADAS



	XS	S	M	L	XL	XXL
A	49	53	57	61	65	69
B	65	68	71	74	77	80

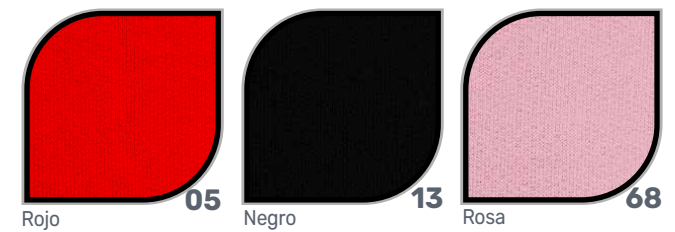

CREATU DISEÑO
FABRICADO EN ESPAÑA
MADE IN SPAIN

UNISEX INVIERNO FELPA
12 JOYLU

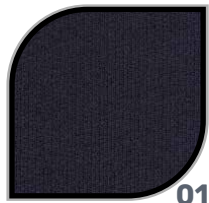

01 Marino

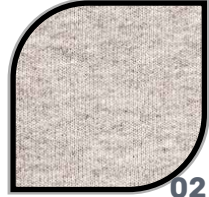

02 Gris

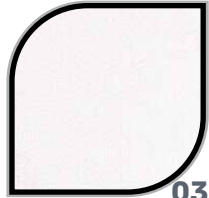

03 Blanco

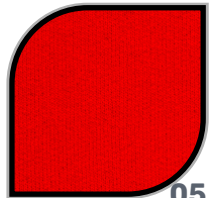

05 Rojo

SUDADERA CAPUCHA CHICAGO Ref. 038

BOLSILLO CANGURO



DESCRIPCIÓN

Sudadera de corte ranglan con capucha doble y bolsillo canguro con doble pespunte en puños y cintura.

TEJIDO

Felpa lisa perchada

COMPOSICIÓN

50% algodón 50% poliéster
285 gr/m²

OPCIONES DE PERSONALIZACIÓN

- ▶ Bordado
- ▶ Serigrafía
- ▶ Vinilo termoadhesivo

MEIDAS APROXIMADAS



	XS	S	M	L	XL	XXL
A	49	53	57	61	65	69
B	65	68	71	74	77	80



AR Marino/Celeste



AY Gris/Plomo

BOLSILLO COMBINADO



36 Blanco/Rojo



AJ Rojo/Marino



CHAQUETA CUELLO ALTO HUESCA

Ref. 031

BOLSILLO FRANCÉS



DESCRIPCIÓN

Chaqueta de corte clásico de cuello alto y bolsillo francés. Puños con canalé y cintura sin canalé.

TEJIDO

Felpa lisa perchada

COMPOSICIÓN

50% algodón 50% poliéster
285 gr/m²

OPCIONES DE PERSONALIZACIÓN

- Bordado
- Serigrafía
- Vinilo termoadhesivo

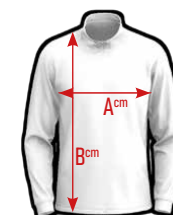

MEDIDAS APROXIMADAS



	XS	S	M	L	XL	XXL
A	49	53	57	61	65	69
B	67	70	73	76	79	82

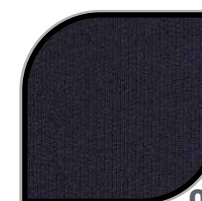

Marino

01

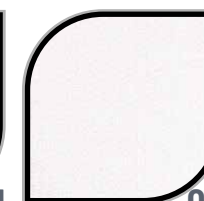

Blanco

03



Negro

13

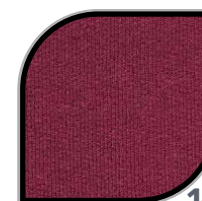

Rioja

16

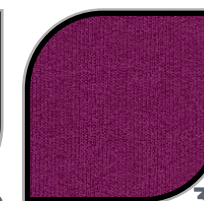

Malva

31

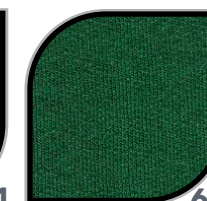

Verde botella

63



UNISEX INVIERNO FELPA

14 JOYLU

CHAQUETA BÓMBER

Ref. 030

BOLSILLO FRANCÉS



DESCRIPCIÓN

Chaqueta de corte clásico de cuello alto y bolsillo francés. Cintura y puños con canalé, con doble pespunte.

TEJIDO

Felpa lisa perchada

COMPOSICIÓN

50% algodón 50% poliéster
285 gr/m²

OPCIONES DE PERSONALIZACIÓN

- Bordado
- Serigrafía
- Vinilo termoadhesivo

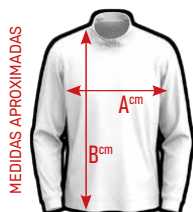

MEIDAS APROXIMADAS



	XS	S	M	L	XL	XXL
A	49	53	57	61	65	69
B	65	68	71	74	77	80



Marino

01

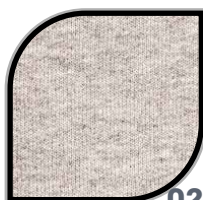

Gris

02



Blanco

03

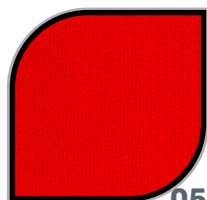

Rojo

05



Negro

13

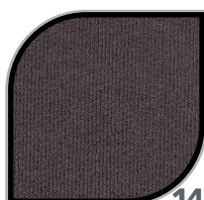

Plomo

14



Náutico

15



CHAQUETA CAPUCHA BOLSILLO CANGURO

Ref. 034



DESCRIPCIÓN

Chaqueta de corte clásico con capucha doble y bolsillos canguro, puños y cintura con canalé con doble pespunte.

TEJIDO

Felpa lisa perchada

COMPOSICIÓN

50% algodón 50% poliéster
285 gr/m²

OPCIONES DE PERSONALIZACIÓN

- ▶ Bordado
- ▶ Serigrafía
- ▶ Vinilo termoadhesivo



MEDIDAS APROXIMADAS



	6/7	8/9	10/11
A	39	42	45
B	50	54	58

	XS	S	M	L	XL	XXL
A	49	53	57	61	65	69
B	65	68	71	74	77	80



Marino

01

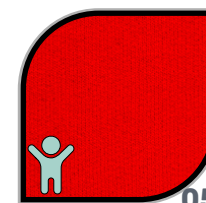

Rojo

05

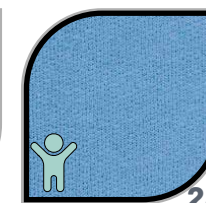

Celeste

25

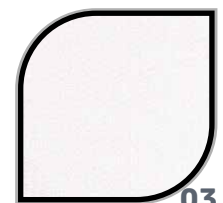

Blanco

03

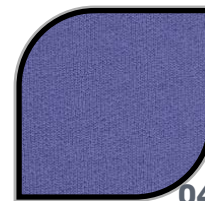

Devín

04



Negro

13

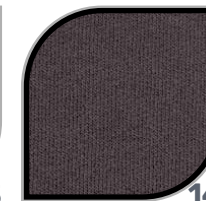

Plomo

14

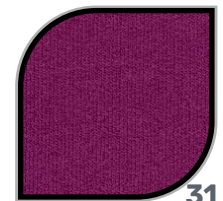

Malva

31

CHAQUETA CAPUÇA BOLSILLO FRANCÉS Ref. 035



DESCRIPCIÓN

Chaqueta de corte clásico con capucha doble y bolsillo francés. Puños y cintura con canalé con doble pesunte.

TEJIDO

Felpa lisa perchada

COMPOSICIÓN

50% algodón 50% poliéster
285 gr/m²

OPCIONES DE PERSONALIZACIÓN

- ▶ Bordado
- ▶ Serigrafía
- ▶ Vinilo termoadhesivo



	XS	S	M	L	XL	XXL
A	49	53	57	61	65	69
B	65	68	71	74	77	80



Marino

01



Gris

02

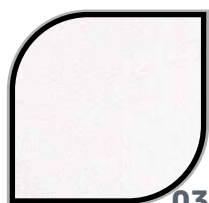

Blanco

03

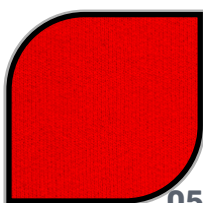

Rojo

05



Negro

13



CHAQUETA CAPUCHA ATLANTA

Ref. 044

BOLSILLO CANGURO

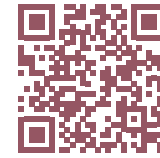

DESCRIPCIÓN

Chaqueta de corte ranglan con capucha doble. Bolsillo de canguro. Con doble pespunte en puños y cintura.

TEJIDO

Felpa lisa perchada

COMPOSICIÓN

50% algodón 50% poliéster
285 gr/m²

OPCIONES DE PERSONALIZACIÓN

- Bordado
- Serigrafía
- Vinilo termoadhesivo

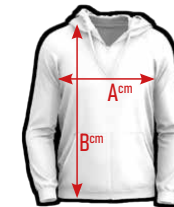

MEDIDAS APROXIMADAS



	XS	S	M	L	XL	XXL
A	49	53	57	61	65	69
B	65	68	71	74	77	80



Marino

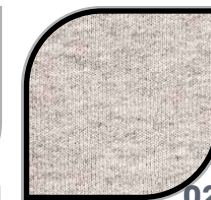

Gris



Blanco

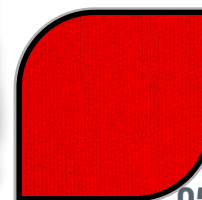

Rojo



Negro



Gris/Negro



Negro/Amarillo Flúor



CHAQUETA TRICOLOR CALIFORNIA

Ref. 078

BOLSILLO CANGURO



DESCRIPCIÓN

Chaqueta de corte ranglan con capucha doble. Bolsillo de canguro. Con doble pespunte en puños y cintura.

TEJIDO

Felpa lisa perchada

COMPOSICIÓN

50% algodón 50% poliéster
285 gr/m²

OPCIONES DE PERSONALIZACIÓN

- ▶ Bordado
- ▶ Serigrafía
- ▶ Vinilo termoadhesivo



	XS	S	M	L	XL	XXL
A	49	53	57	61	65	69
B	65	68	71	74	77	80



Gris 02



Blanco 03



Rojo 05



Negro 13



Náutico 15



POLO FELPA CÁDIZ Ref. 102



DESCRIPCIÓN

Polo de felpa de corte clásico. Cuello de tricotosa. Con doble pespunte en puños y cintura.

TEJIDO

Felpa lisa perchada

COMPOSICIÓN

50% algodón 50% poliéster
285 gr/m²

OPCIONES DE PERSONALIZACIÓN

- Bordado
- Serigrafía
- Vinilo termoadhesivo

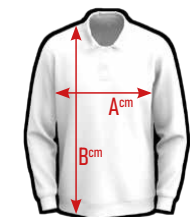

MEDIDAS APROXIMADAS



	XS	S	M	L	XL	XXL
A	49	53	57	61	65	69
B	65	68	71	74	77	80

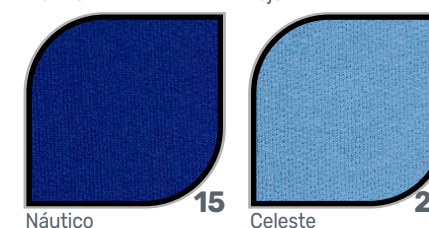

CHAQUETA WOMAN LISBOA Ref. 050

BOLSILLO CANGURO



DESCRIPCIÓN

Chaqueta de corte ranglan slim fit con capucha doble y bolsillos. Con doble pespunte en puños y cintura.

TEJIDO

Felpa lisa perchada

COMPOSICIÓN

50% algodón 50% poliéster
285 gr/m²

OPCIONES DE PERSONALIZACIÓN

- Bordado
- Serigrafía
- Vinilo termoadhesivo

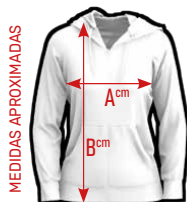

	XXS	XS	S	M	L	XL
A	38	42	46	50	55	60
B	57	59,5	62	64,5	67	69,5

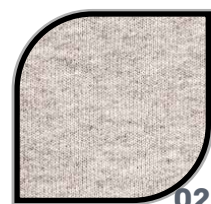

Gris

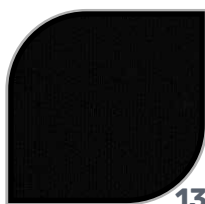

Negro

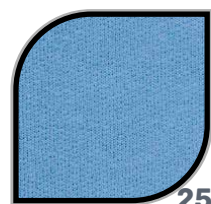

Celeste

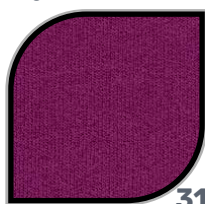

Malva

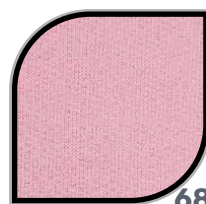

Rosa



UNISEX INVIERNO FELPA

JOYLU 21

PANTALÓN SPORT Ref. 003

BOLSILLO FRANCÉS



DESCRIPCIÓN

Pantalón de felpa de corte deportivo con bolsillos laterales. Cintura elástica con cordón. Bajo con puño.

TEJIDO

Felpa lisa perchada

COMPOSICIÓN

50% algodón 50% poliéster
285 gr/m²

OPCIONES DE PERSONALIZACIÓN

- Bordado
- Serigrafía
- Vinilo termoadhesivo



MEDIDAS APROXIMADAS

	2/3	4/5	6/7	8/9	10/11
A	24	25	26	27	28
B	62	69	76	83	90

	XS	S	M	L	XL	XXL
A	30	32	34	36	38	40
B	98	101	104	107	110	113



Marino

01

Gris

02



Blanco

03

Negro

13



PANTALÓN CLASSIC Ref. 004

BOLSILLO FRANCÉS



DESCRIPCIÓN

Pantalón de felpa de corte clásico con bolsillos laterales. Cintura elástica con cordón. Bajo con dobladillo.

TEJIDO

Felpa lisa perchada

COMPOSICIÓN

50% algodón 50% poliéster
285 gr/m²

OPCIONES DE PERSONALIZACIÓN

- ▶ Bordado
- ▶ Serigrafía
- ▶ Vinilo termoadhesivo



	2/3	4/5	6/7	8/9	10/11
A	24	25	26	27	28
B	62	69	76	83	90



MEASURAS APROXIMADAS

	XS	S	M	L	XL	XXL
A	30	32	34	36	38	40
B	98	101	104	107	110	113

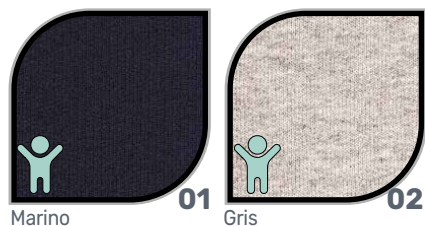

Marino

01

Gris

02

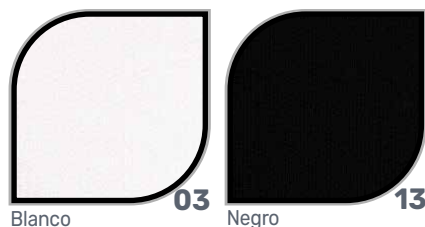

Blanco

03

Negro

13



UNISEX INVIERNO FELPA

JOYLU 23

BERMUDA FELPA VERANO

Ref. 059
BOLSILLO FRANCÉS

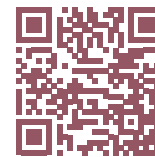

DESCRIPCIÓN

Bermuda de felpa de corte deportivo con bolsillos laterales. Cintura elástica con cordón.

TEJIDO

Felpa lisa sin perchar

COMPOSICIÓN

50% algodón 50% poliéster
285 gr/m²

OPCIONES DE PERSONALIZACIÓN

- Bordado
- Serigrafía
- Vinilo termoadhesivo



MEDIDAS APROXIMADAS



	2/3	4/5	6/7	8/9	10/11
A	24	25	26	27	28
B	28	31	34	37	40

	XS	S	M	L	XL	XXL
A	30	32	34	36	38	40
B	41	43	45	47	49	51



Marino

01



Negro

13



CAMISETA MANGA CORTA

50% alg./pol.

Ref. 124



DESCRIPCIÓN

Camiseta básica de cuello redondo y manga corta. Hombros avanzados. Doble pespunte en cuello, bajo y hombros.

TEJIDO

Pulito liso

COMPOSICIÓN

50% algodón 50% poliéster
160 gr/m²

OPCIONES DE PERSONALIZACIÓN

- ▶ Bordado
- ▶ Serigrafía
- ▶ Vinilo termoadhesivo

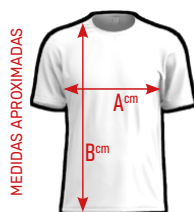

MEDIDAS APROXIMADAS



	XS	S	M	L	XL	XXL	3XL
A	48	50	53	56	59	62	65
B	67	70	72	74	76	78	80



Marino

01

Gris

02

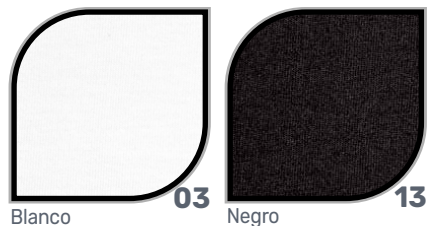

Blanco

03

Negro

13



CAMISETA MANGA LARGA

50% alg./pol. Ref. 125



DESCRIPCIÓN

Camiseta de cuello redondo. Hombros avanzados.
Dobles pespuntos en cuello, bajo, mangas y hombros.

TEJIDO

Pulito liso

COMPOSICIÓN

50% algodón 50% poliéster
160 gr/m²

OPCIONES DE PERSONALIZACIÓN

- Bordado
- Serigrafía
- Vinilo termoadhesivo

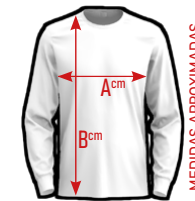

MEDIDAS APROXIMADAS



	XS	S	M	L	XL	XXL	3XL
A	48	50	53	56	59	62	65
B	67	70	72	74	76	78	80



Marino

01

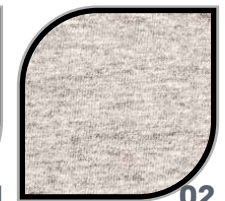

Gris

02

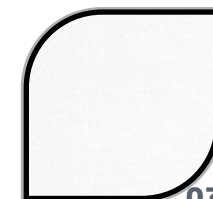

Blanco

03



Negro

13



UNISEX VERANO

26 JOYLU

POLO MANGA CORTA

50% alg./pol.

Ref. 126



DESCRIPCIÓN

Polo de manga corta. Elástico en manga. Hombros avanzados. Dobles pespuntos en bajo y hombros. Dos botones.

TEJIDO

Piqué

COMPOSICIÓN

50% algodón 50% poliéster
210 gr/m²

OPCIONES DE PERSONALIZACIÓN

- ▶ Bordado
- ▶ Serigrafía
- ▶ Vinilo termoadhesivo

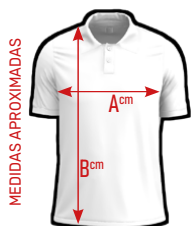

	XS	S	M	L	XL	XXL	3XL
A	48	50	53	56	59	62	65
B	67	70	72	74	76	78	80

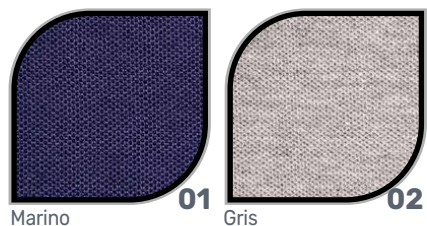

POLO MANGA LARGA

50% alg./pol.

Ref. 127



DESCRIPCIÓN

Polo de manga larga. Puño en manga. Hombros avanzados. Dobles pespuntos en bajo y hombros. Dos botones.

TEJIDO

Piqué

COMPOSICIÓN

50% algodón 50% poliéster
210 gr/m²

OPCIONES DE PERSONALIZACIÓN

- ▶ Bordado
- ▶ Serigrafía
- ▶ Vinilo termoadhesivo



MEDIDAS APROXIMADAS



	XS	S	M	L	XL	XXL	3XL
A	48	50	53	56	59	62	65
B	67	70	72	74	76	78	80

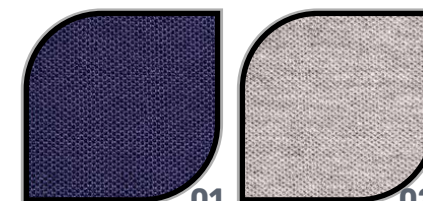

Marino

01

Gris

02

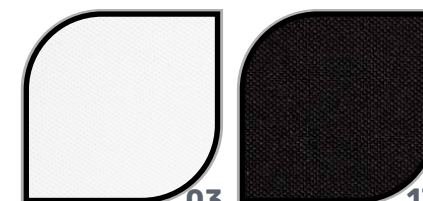

Blanco

03

Negro

13



UNISEX VERANO

28 JOYLU

CAMISETA COMBI CASTELLÓN

Ref. 107



DESCRIPCIÓN

Camiseta básica de cuello redondo y manga corta. Cuello y elástico de manga en lycra contraste. Hombros avanzados. Doble pespunte en cuello, bajo y hombros.

TEJIDO

Punto liso de algodón peinado

COMPOSICIÓN

100% algodón
170 gr/m²

OPCIONES DE PERSONALIZACIÓN

- ▶ Bordado
- ▶ Serigrafía
- ▶ Vinilo termoadhesivo

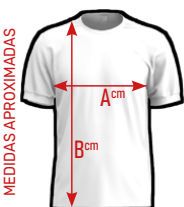

	XS	S	M	L	XL	XXL
A	48	50	53	56	59	62
B	67	70	72	74	76	78



Blanco/Negro

09



Blanco/Rojo

36



Blanco/Náutico

38



Negro/Pistacho

44



Náutico/Blanco

55





CAMISETA VALENCIA

Ref. 106

DESCRIPCIÓN

Camiseta básica de cuello redondo y manga corta. Cuello en lycra 1x1. Hombros avanzados. Doble pespunte en cuello, bajo y hombros.

TEJIDO

Punto liso de algodón peinado

COMPOSICIÓN

100% algodón
170 gr/m²

OPCIONES DE PERSONALIZACIÓN

- Bordado
- Serigrafía
- Vinilo termoadhesivo



	2/3	4/5	6/7	8/9	10/11
A	32	35	38	41	44
B	42	47	52	57	62

	XS	S	M	L	XL	XXL	3XL
A	48	50	53	56	59	62	65
B	67	70	72	74	76	78	80

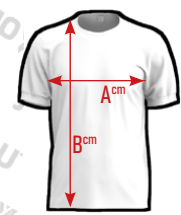

MEDIDAS APROXIMADAS

 Marino 01	 Gris 02		
 Blanco 03	 Rojo 05		
 Negro 13	 Náutico 15		
 Verde Caza 19	 Celeste 25		
 Pistacho 30	 Malva 31	 Burdeos 34	 Turquesa 35
 Naranja 47	 Girasol 56	 Verde Billar 71	 Plomo 14

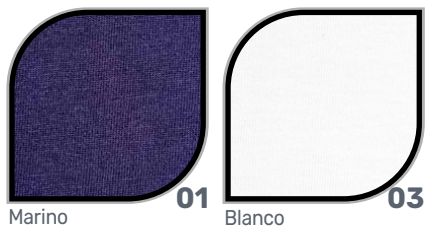

Marino

Blanco

POLO PUNTO LISO

ALMERÍA

Ref. 108



Negro

Náutico



Blanco/Rojo

Blanco/Marino



Rojo/Negro

Marino/Rojo



Negro/Pistacho

Gris/Negro

DESCRIPCIÓN

Polo de manga corta. Cuello de tricotosa y elástico en manga a contraste. Hombros avanzados. Dobles pespuntos en bajo y hombros. Dos botones.

TEJIDO

Punto liso de algodón peinado

COMPOSICIÓN

100% algodón
170 gr/m²

OPCIONES DE PERSONALIZACIÓN

- ▶ Bordado
- ▶ Serigrafía
- ▶ Vinilo termoadhesivo

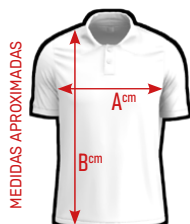

MEDIDAS APROXIMADAS

	XS	S	M	L	XL	XXL
A	48	50	53	56	59	62
B	65	68	70	72	74	76



Naranja/Negro



Chocolate/Tierra

Náutico/Marino



Pistacho/Negro

Celeste/Marino





POLO MÁLAGA

Ref. 020

DESCRIPCIÓN

Polo de manga corta. Cuello de tricotosa y elástico en manga. Hombros avanzados. Dobles pespuntos en bajo y hombros. Dos botones.

TEJIDO

Piqué de algodón peinado

COMPOSICIÓN

100% algodón
220 gr/m²

OPCIONES DE PERSONALIZACIÓN

- Bordado
- Serigrafía
- Vinilo termoadhesivo



	2/3	4/5	6/7	8/9	10/11
A	32	35	38	41	44
B	42	47	52	57	62

	XS	S	M	L	XL	XXL	3XL
A	48	50	53	56	59	62	65
B	65	68	70	72	74	76	79

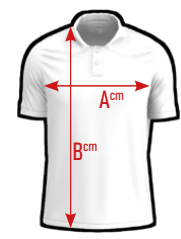
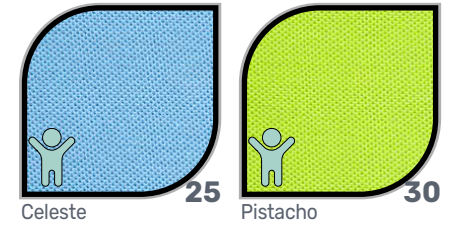

MEDIDAS APROXIMADAS

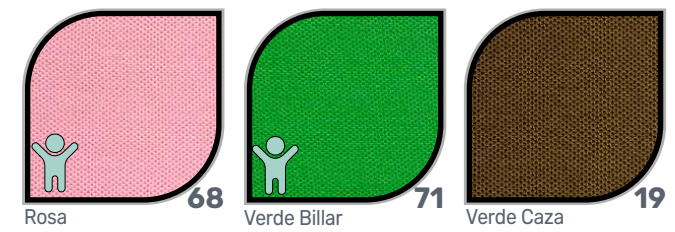
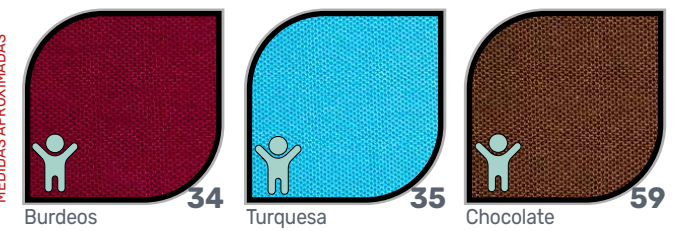

POLO ESPAÑA Ref. 120



DESCRIPCIÓN

Polo de manga corta. Cuello de tricotosa y elástico en manga con bandera de "España" en filo. Hombros avanzados. Dobles pespuntos en bajo y hombros. Dos botones.

TEJIDO

Piqué de algodón peinado

COMPOSICIÓN

100% algodón
220 gr/m²

OPCIONES DE PERSONALIZACIÓN

- ▶ Bordado
- ▶ Serigrafía
- ▶ Vinilo termoadhesivo



	4/5	6/7	8/9	10/11
A	35	38	41	44
B	47	52	57	62

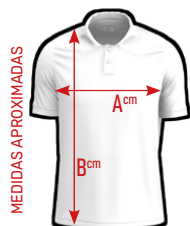

MEDIDAS APROXIMADAS

	XS	S	M	L	XL	XXL
A	48	50	53	56	59	62
B	65	68	70	72	74	76



Marino

01

Blanco

03

Rojo

05

Náutico

15



Gris

02

Negro

13

Verde Caza

19

Chocolate

59



CAMISETA MICROPOLIÉSTER OLIMPO Ref. 181



DESCRIPCIÓN

Camiseta técnica de cuello redondo y manga corta tipo ranglan. Costuras laterales para una mejor adaptación al cuerpo. Ribete en cuello en tejido lycra 1x1. Dobles pespuntos en bajo, mangas y hombros.

TEJIDO

Micropoliéster

COMPOSICIÓN

100% poliéster
130 gr/m²

OPCIONES DE PERSONALIZACIÓN

- Bordado
- Serigrafía
- Vinilo termoadhesivo
- Sublimación

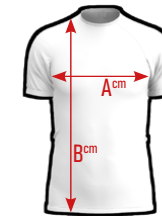

MEDIDAS APROXIMADAS

	4/5	6/7	8/9	10/11
A	35	38	41	44
B	47	52	57	62

	XS	S	M	L	XL	XXL	3XL
A	48	50	53	56	59	62	65
B	67	70	72	74	76	78	80

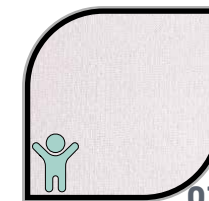

Blanco

03

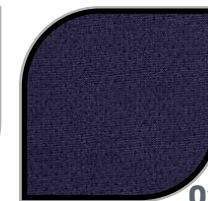

Marino

01

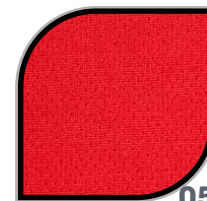

Rojo

05

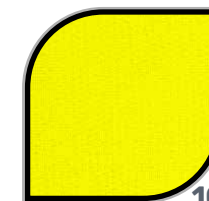

Amarillo Flúor

10



Negro

13



Náutico

15



PANTALÓN MICROPOLIÉSTER

MARTE

Ref. 171



DESCRIPCIÓN

Pantalón corto con cintura elástica y cordón para un mejor ajuste.

TEJIDO

Micropoliéster

COMPOSICIÓN

100% poliéster
130 gr/m²

OPCIONES DE PERSONALIZACIÓN

- Bordado
- Serigrafía
- Vinilo termoadhesivo
- Sublimación



	4/5	6/7	8/9	10/11
A	22.5	24.5	26.5	28.5
B	27	29	31	33

MEIDAS APROXIMADAS

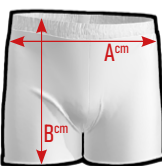

	XS	S	M	L	XL	XXL
A	31	33	35	37	39	41
B	35	37	38	39	40	41



Marino

01



Rojo

05



Náutico

15



Pistacho

30

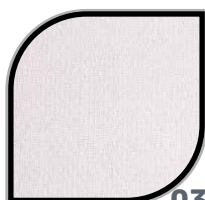

Blanco

03

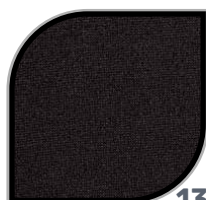

Negro

13



CHALECO ACOLCHADO Ref. 319



DESCRIPCIÓN

Chaleco ligero acolchado con cremalleras inversas delante y bolsillos con tirador pulgar. Tratamiento repelente al agua. Diseño acolchado 5,5 cm. en horizontal.

COMPOSICIÓN

Exterior: 100% poliamida
Relleno: Crush padding 100% poliéster, 60 gr

OPCIONES DE PERSONALIZACIÓN

- Bordado
- Serigrafía
- Vinilo termoadhesivo



	XS	S	M	L	XL	XXL
A	51	53,5	56	58,5	61	63,5
B	65	67	69	71	73	75



Marino

01



Gris

02



Negro

13



Verde Caza

19

CHAQUETA ACOLCHADA Ref. 318



DESCRIPCIÓN

Chaqueta ligera acolchada con cremalleras inversas delante y bolsillos con tirador pulgar. Tratamiento repelente al agua. Diseño acolchado 5,5 cm en horizontal.

COMPOSICIÓN

Exterior: 100% poliamida

Relleno: Crush padding 100% poliéster, 60 gr

OPCIONES DE PERSONALIZACIÓN

- Bordado
- Serigrafía
- Vinilo termoadhesivo

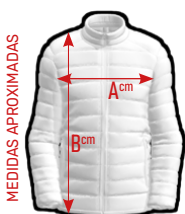

MEDIDAS APROXIMADAS



	XS	S	M	L	XL	XXL
A	51,5	54	56,5	59	61,5	64
B	70	72	74	76	78	80



Marino

01



Gris

02



Negro

13



Verde Caza

19



PARKA 3/4 ACOLCHADA Ref. 320



DESCRIPCIÓN

Parka 3/4 ligera acolchada con capucha y cremallera inversa delante con doble tirador para apertura de abajo/arriba y bolsillos con cremallera. Tratamiento repelente al agua. Diseño acolchado 5,5 cm en horizontal.

COMPOSICIÓN

Exterior: 100% poliamida
Relleno: Crush padding 100% poliéster, 60 gr

OPCIONES DE PERSONALIZACIÓN

- Bordado
- Serigrafía
- Vinilo termoadhesivo



MEDIDAS APROXIMADAS



	XS	S	M	L	XL	XXL
A	51,5	54	56,5	59	61,5	64
B	84	86	88	90	91	94



Negro

13

CHAQUETA SOFTSHELL BASIC Ref. 308



DESCRIPCIÓN

Chaqueta con tecnología softshell triple capa, terminación waterproof. Puños ajustables. Bajo ajustable con tensores. Bolsillos laterales con cierre y cremalleras a contraste.

COMPOSICIÓN

97% poliamida 3% spandex
285 gr/m²

OPCIONES DE PERSONALIZACIÓN

- Bordado
- Serigrafía
- Vinilo termoadhesivo

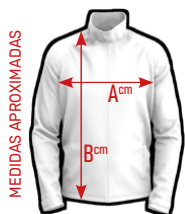

	XS	S	M	L	XL	XXL	3XL
A	47	50	53	57	61	65	69
B	68	69	70	71	72	73	74



Marino

01

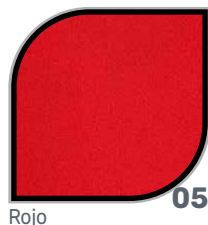

Rojo

05



Verde

08



Negro

13

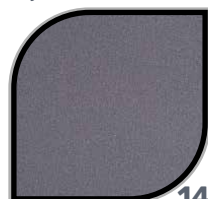

Plomo

14



Náutico

15



CHALECO SOFTSHELL Ref. 315



DESCRIPCIÓN

Chaleco con tecnología softshell triple capa, terminación waterproof. Bajo ajustable con tensores. Bolsillos laterales y bolsillo en pecho con cremallera.

COMPOSICIÓN

97% poliamida 3% spandex
330 gr/m²

OPCIONES DE PERSONALIZACIÓN

- Bordado
- Serigrafía
- Vinilo termoadhesivo

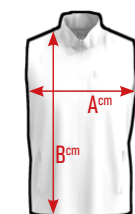

MEDIDAS APROXIMADAS



	XS	S	M	L	XL	XXL
A	51	53,5	56	58,5	51	63,5
B	65	67	69	71	73	75



Marino

01



Negro

13



Plomo

14



Verde Caza

19

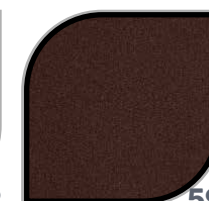

Chocolate

59

CHAQUETA SOFTSHELL Ref. 314



DESCRIPCIÓN

Chaqueta con tecnología softshell triple capa, terminación waterproof e interior con rejilla transpirable. Puños ajustables. Bajo ajustable con tensores. Bolsillos laterales y bolsillo en pecho con cierre.

COMPOSICIÓN

97% poliamida 3% spandex
330 gr/m²

OPCIONES DE PERSONALIZACIÓN

- Bordado
- Serigrafía
- Vinilo termoadhesivo

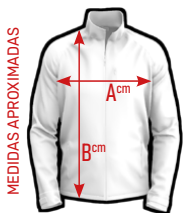

	XS	S	M	L	XL	XXL
A	51,5	54	56,5	59	61,5	64
B	70	72	74	76	78	80



Marino

01



Negro

13

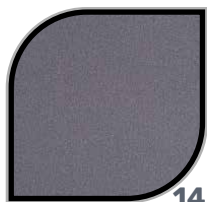

Plomo

14

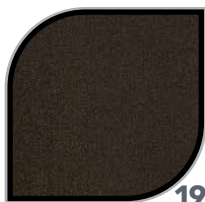

Verde Caza

19

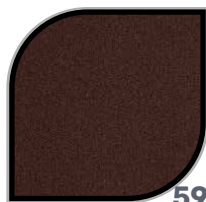

Chocolate



CHALECO POLAR Ref. 317



DESCRIPCIÓN

Chaleco de corte clásico con cuello alto y cremalleras a tono. Bolsillos con cremallera, tratamiento anti-peeling en las dos caras.

TEJIDO

Felpa polar

COMPOSICIÓN

100% poliéster
360 gr/m²

OPCIONES DE PERSONALIZACIÓN

- Bordado
- Serigrafía
- Vinilo termoadhesivo

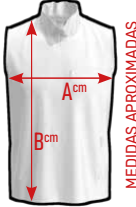

MEDIDAS APROXIMADAS



	XS	S	M	L	XL	XXL
A	51	53,5	56	58,5	61	63,5
B	65	67	69	71	73	75



Marino

01



Negro

13

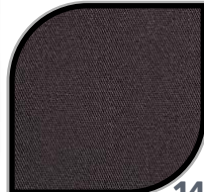

Plomo

14



Verde Caza

19



Chocolate

59

CHAQUETA POLAR Ref. 316



DESCRIPCIÓN

Chaqueta de corte clásico con cuello alto y cremalleras a tono. Bolsillos con cremallera, tratamiento antipeeling en las dos caras.

TEJIDO

Felpa polar

COMPOSICIÓN

100% poliéster
360 gr/m²

OPCIONES DE PERSONALIZACIÓN

- Bordado
- Serigrafía
- Vinilo termoadhesivo

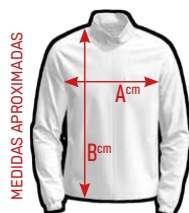

MEDIDAS APROXIMADAS

	XS	S	M	L	XL	XXL
A	51,5	54	56,5	59	61,5	64
B	70	72	74	76	78	80



Marino

01



Negro

13

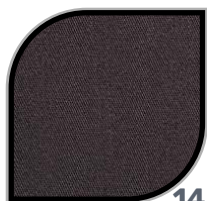

Plomo

14



Verde Caza

19



Chocolate

59



CHUBASQUERO CICLÓN Ref. 029



DESCRIPCIÓN

Chubasquero con tratamiento impermeable de poliuretano. Interior de malla. Tensores en bajo y cremallera central con tapeta. Capucha oculta ajustable con cordón.

COMPOSICIÓN

Exterior: 100% poliamida
Malla: 100% poliéster

OPCIONES DE PERSONALIZACIÓN

- Bordado
- Serigrafía
- Vinilo termoadhesivo

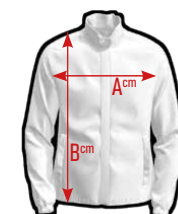

MEDIDAS APROXIMADAS



	XS	S	M	L	XL	XXL
A	54	57	60	63	66	69
B	69	71	73	75	77	79



Marino

01

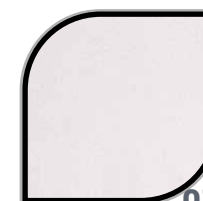

Blanco

03

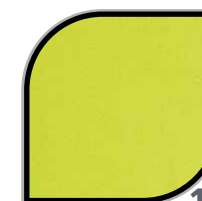

Amarillo Flúor

10



Naranja Flúor

11



Negro

13



Náutico

15

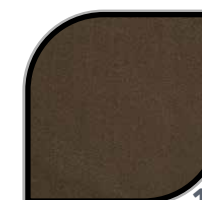

Verde Caza

19

JERSEY DE VESTIR CUELLO CAJA Ref. 151



TEJIDO

Punto de galga 12

COMPOSICIÓN

100% algodón

OPCIONES DE PERSONALIZACIÓN

- Bordado
- Serigrafía
- Vinilo termoadhesivo

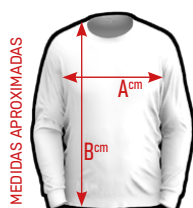

	S	M	L	XL	XXL
A	52	54	56	58	60
B	67	68	69	70	71



Marino

01

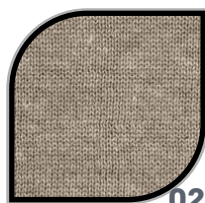

Gris

02

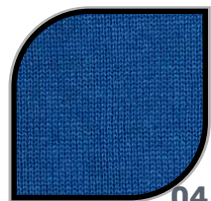

Devín

04

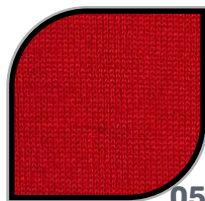

Rojo

05



Verde

08

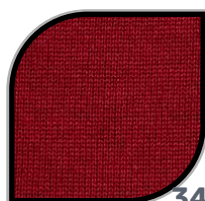

Burdeos

34



Marengo

74

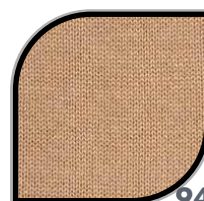

Beige

94



JERSEY DE VESTIR CUELLO PICO Ref. 150

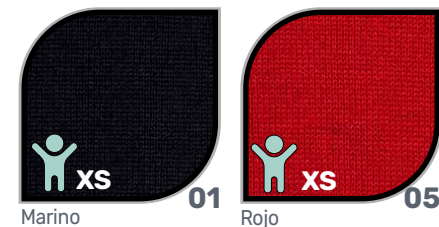

Marino

Rojo

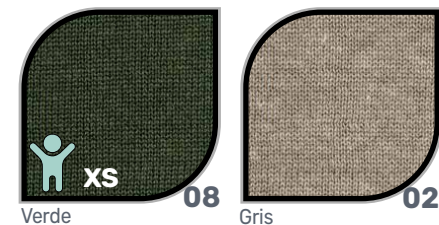

Verde

Gris

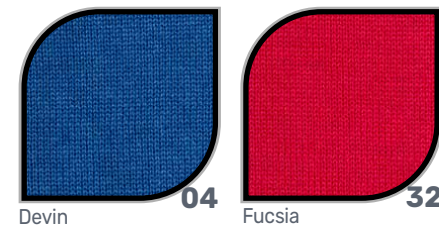

Devín

Fucsia



Burdeos

Chocolate

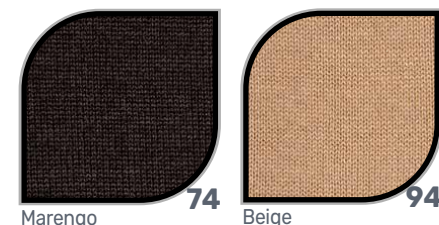

Marengo

Beige

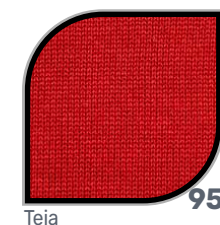

Teja

TEJIDO

Punto de galga 12

COMPOSICIÓN

100% algodón

OPCIONES DE PERSONALIZACIÓN

- Bordado
- Serigrafía
- Vinilo termoadhesivo



	4/5	6/7	8/9	10/11
A	37	40	43	46
B	49	53	57	61

	XS	S	M	L	XL	XXL
A	49	52	54	56	58	60
B	64	67	68	69	70	71



MEDIDAS APROXIMADAS



CHAQUETA DE VESTIR

Ref. 153



DESCRIPCIÓN

Chaqueta con cierre de cremallera, cuello alto y dos bolsillos laterales.

TEJIDO

Pulto de galga 7

COMPOSICIÓN

100% algodón

OPCIONES DE PERSONALIZACIÓN

- Bordado
- Serigrafía
- Vinilo termoadhesivo



	S	M	L	XL	XXL
A	52	54	56	58	60
B	67	68	69	70	71

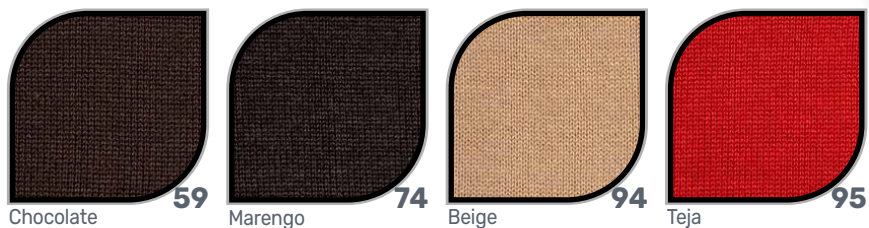
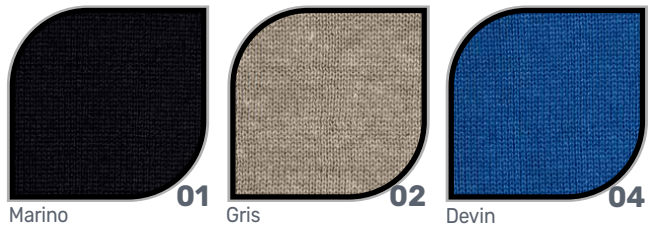
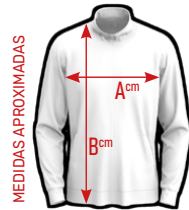



SOFTSHELL CAPUCHA WOMAN Ref. 307



DESCRIPCIÓN

Chaqueta con tecnología softshell triple capa, terminación waterproof. Patrón slim fit especial. Capucha desmontable. Interiores en rejilla transpirable. Puños y bajo ajustable. Dos bolsillos laterales más uno en pecho y cremalleras reflectantes..

COMPOSICIÓN

97% poliamida 3% spandex
330 gr/m²

OPCIONES DE PERSONALIZACIÓN

- Bordado
- Serigrafía
- Vinilo termoadhesivo



MEDIDAS APROXIMADAS



	XS	S	M	L	XL
A	47.5	50	52.5	55	57.5
B	62	63	64	65	65

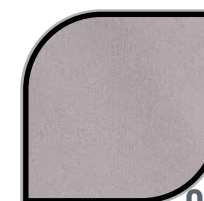

Gris

02

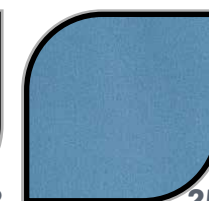

Celeste

25

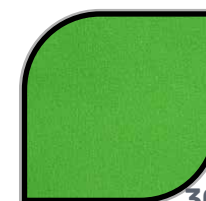

Pistacho

30

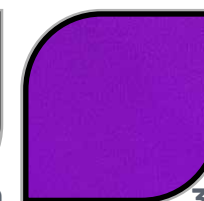

Malva

31

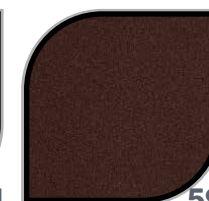

Chocolate

59

POLO TARIFA

Ref. 023



DESCRIPCIÓN

Polo de manga larga. Cuello de tricotosa y elástico en manga. Hombros avanzados. Dobles pespuntos en bajo y hombros. Tres botones.

TEJIDO

Piqué de algodón peinado

COMPOSICIÓN

100% algodón
220 gr/m²

OPCIONES DE PERSONALIZACIÓN

- ▶ Bordado
- ▶ Serigrafía
- ▶ Vinilo termoadhesivo

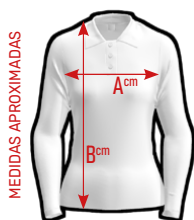

	XS	S	M	L	XL
A	44	46	48	50	52
B	58	60	62	64	66

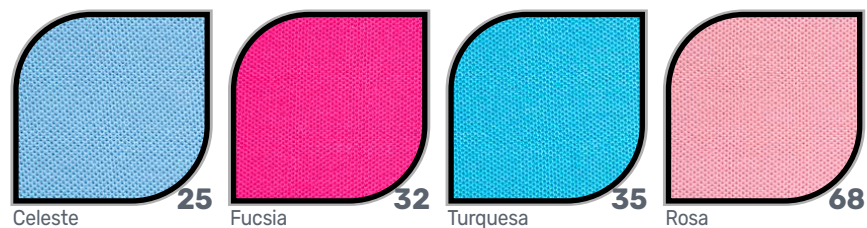
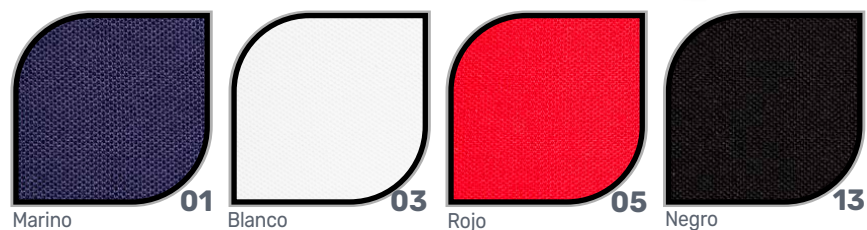

MUJER



CAMISETA NERJA Ref. 010

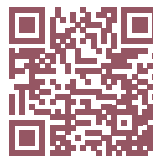

DESCRIPCIÓN

Camiseta básica entallada de cuello redondo y manga corta. Cuello en lycra 1x1. Hombros avanzados. Doble pespunte en cuello, bajos y hombros.

TEJIDO

Punto liso de algodón peinado

COMPOSICIÓN

100% algodón
170 gr/m²

OPCIONES DE PERSONALIZACIÓN

- Bordado
- Serigrafía
- Vinilo termoadhesivo

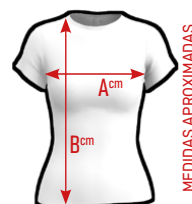

MEDIDAS APROXIMADAS

	XS	S	M	L	XL
A	43	45	47	49	51
B	58	60	62	64	66

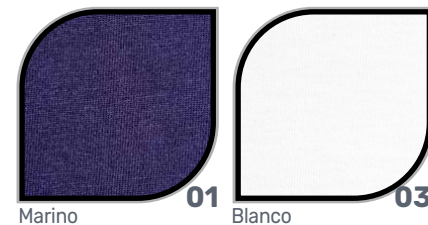

Marino

Blanco

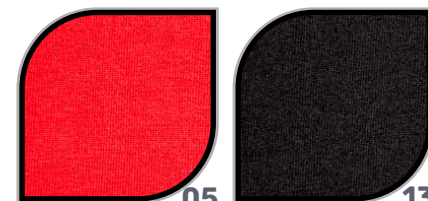

Rojo

Negro

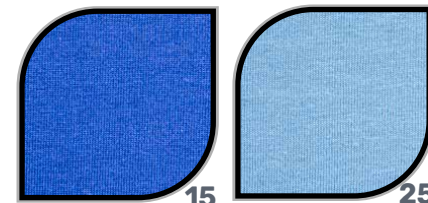

Náutico

Celeste

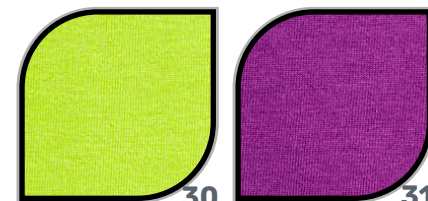

Pistacho

Malva

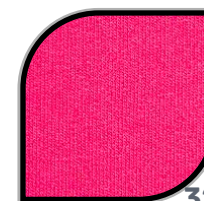

Fucsia

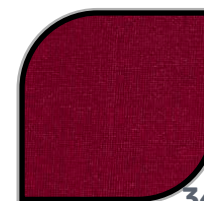

Burdeos

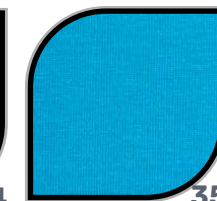

Turquesa



Naranja

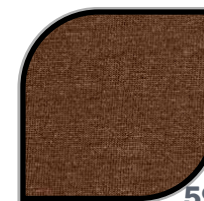

Chocolate

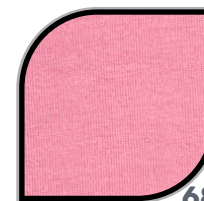

Rosa

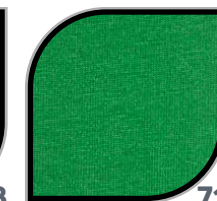

Verde Billar

POLO MOTRIL

Ref. 041



DESCRIPCIÓN

Polo de manga corta. Cuello de tricotosa y elástico en manga. Hombros avanzados. Dobles pespuntos en bajo y hombros. Tres botones.

TEJIDO

Piqué de algodón peinado

COMPOSICIÓN

100% algodón
220 gr/m²

OPCIONES DE PERSONALIZACIÓN

- Bordado
- Serigrafía
- Vinilo termoadhesivo

MEDIDAS APROXIMADAS

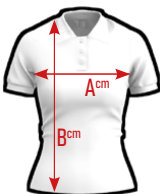

	XS	S	M	L	XL
A	44	46	48	50	52
B	58	60	62	64	66

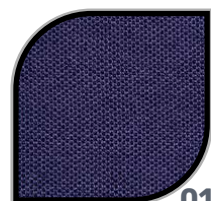

Marino

01

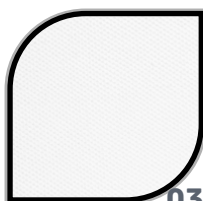

Blanco

03



Rojo

05



Negro

13

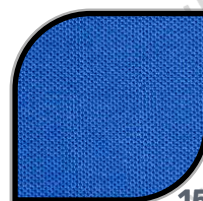

Náutico

15

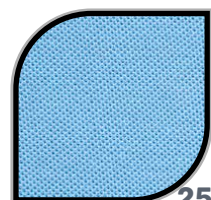

Celeste

25

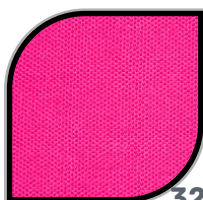

Fucsia

32

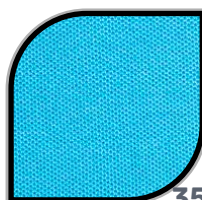

Turquesa

35

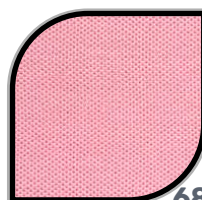

Rosa

68

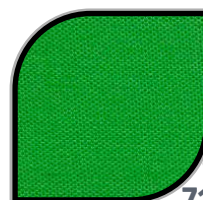

Verde Billar

71

MUJER



POLO ESPAÑA WOMAN Ref. 121

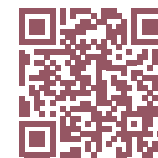

DESCRIPCIÓN

Polo de manga corta. Cuello de tricotsa y elástico en manga con bandera de "España" en filo. Hombros avanzados. Dobles pespuntos en bajo y hombros. Tres botones.

TEJIDO

Piqué de algodón peinado

COMPOSICIÓN

100% algodón
220 gr/m²

OPCIONES DE PERSONALIZACIÓN

- Bordado
- Serigrafía
- Vinilo termoadhesivo

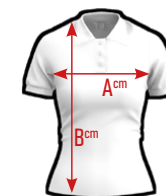

MEDIDAS APROXIMADAS



	XS	S	M	L	XL
A	44	46	48	50	52
B	58	60	62	64	66



Marino

01



Blanco

03



Rojo

05

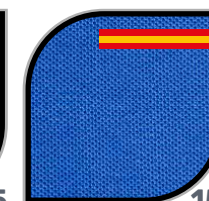

Náutico

15



Chocolate

59

LEGGINS CORTO NANTES

Ref. 175



DESCRIPCIÓN

Leggins corto con cintura elástica y costuras laterales. Diseño anatómico y tejido suave.

TEJIDO

Punto liso de algodón peinado

COMPOSICIÓN

92% algodón 8% spandex
240 gr/m²

OPCIONES DE PERSONALIZACIÓN

- Bordado
- Serigrafía
- Vinilo termoadhesivo



	4/5	6/7	8/9	10/11
A	22	24	26	28
B	22	23	24	25

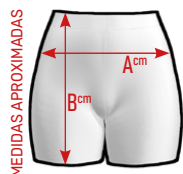

MEDIDAS APROXIMADAS

	XS	S	M	L	XL	XXL
A	30	32	34	36	38	40
B	30	31	32	33	34	35

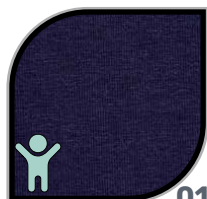

Marino

01



Gris

02



Negro

13

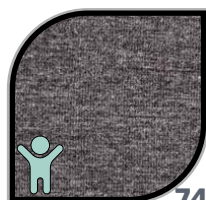

Marengo

74



MUJER



LEGGINS PIRATA NIZA Ref. 176



DESCRIPCIÓN

Leggins pirata con cintura elástica y costuras laterales. Diseño anatómico y tejido suave.

TEJIDO

Punto liso de algodón peinado

COMPOSICIÓN

92% algodón 8% spandex
240 gr/m²

OPCIONES DE PERSONALIZACIÓN

- Bordado
- Serigrafía
- Vinilo termoadhesivo

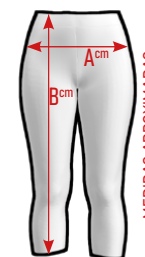

MEDIDAS APROXIMADAS

	4/5	6/7	8/9	10/11
A	22	24	26	28
B	36	43	50	57

	XS	S	M	L	XL	XXL
A	30	32	34	36	38	40
B	65	66	67	68	69	70

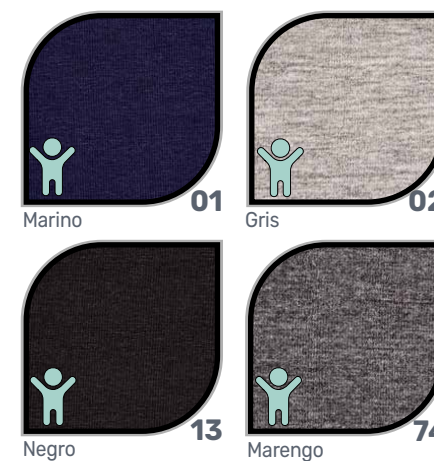

LEGGINS LARGO LYON

Ref. 177



DESCRIPCIÓN

Leggins largo con cintura elástica y costuras laterales. Diseño anatómico y tejido suave.

TEJIDO

Punto liso de algodón peinado

COMPOSICIÓN

92% algodón 8% spandex
240 gr/m²

OPCIONES DE PERSONALIZACIÓN

- Bordado
- Serigrafía
- Vinilo termoadhesivo



	4/5	6/7	8/9	10/11		
A	22	24	26	28		
B	60	68	76	84		
	XS	S	M	L	XL	XXL
A	30	32	34	36	38	40
B	95	96	97	98	99	100



MUJER

SUDADERA BÁSICA ALTA VISIBILIDAD

Ref. 032



DESCRIPCIÓN

Sudadera de corte clásico de cuello redondo con dos bandas reflectantes en pecho, espalda y mangas. Costuras reforzadas en hombros y sisa, así como doble pespunte en cuellos, puños y cintura.

TEJIDO

Felpa lisa perchada

COMPOSICIÓN

50% algodón 50% poliéster
285 gr/m²

OPCIONES DE PERSONALIZACIÓN

- Bordado
- Serigrafía
- Vinilo termoadhesivo



MEDIDAS APROXIMADAS



	S	M	L	XL	XXL
A	53	57	61	65	69
B	71	74	77	80	83



Marino

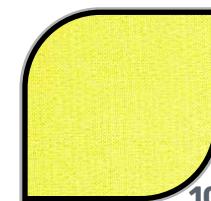

Amarillo Flúor

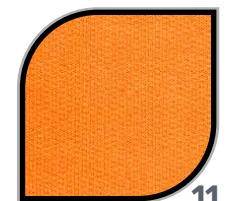

Naranja Flúor



SUDADERA ORIGINAL ALTA VISIBILIDAD

Ref. 033



DESCRIPCIÓN

Sudadera de corte clásico de cuello alto y media cremallera con dos bandas reflectantes en pecho, espalda y mangas. Costuras reforzadas en hombros y sisa, así como doble pespunte en puños y cintura.

TEJIDO

Felpa lisa perchada

COMPOSICIÓN

50% algodón 50% poliéster
285 gr/m²

OPCIONES DE PERSONALIZACIÓN

- Bordado
- Serigrafía
- Vinilo termoadhesivo

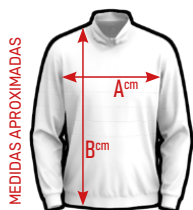

	S	M	L	XL	XXL
A	53	57	61	65	69
B	71	74	77	80	83



Marino

01

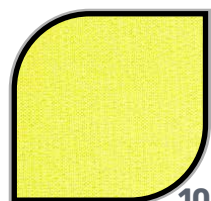

Amarillo Flúor

10

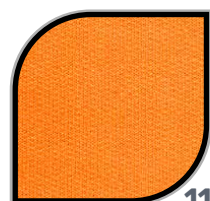

Naranja Flúor

11



PANTALÓN SPANDEX MULTIBOLSILLOS Ref. 143



DESCRIPCIÓN

Pantalón sarga con culera, cintura con trevillas y elástico para mejor ajuste. Dos bolsillos fuelle con cierre de velcro en laterales, dos bolsillos parche con cierre de velcro en culera y dos bolsillos costados.

TEJIDO

Sarga

COMPOSICIÓN

65% poliéster 35% algodón 2% elastano
250 gr/m²

OPCIONES DE PERSONALIZACIÓN

- Bordado
- Serigrafía
- Vinilo termoadhesivo

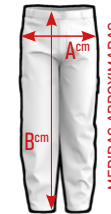

MEDIDAS APROXIMADAS



	XS	S	M	L	XL	XXL
A	33/38	37/43	40/46	44/51	48/55	52/59
B	108	109	110	111	112	113



Marino

01



Negro

13

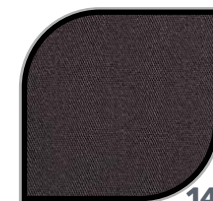

Plomo

14

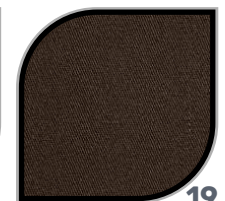

Verde Caza

19

BOLSO MULTIDEPORTE CUADRADO

Ref. B001



DESCRIPCIÓN

Bolso cuadrado multideporte con zapatillero independiente rígido. Bolsillo lateral.

COMPOSICIÓN

Poliéster 600D

OPCIONES DE PERSONALIZACIÓN

- Bordado
- Serigrafía
- Vinilo termoadhesivo

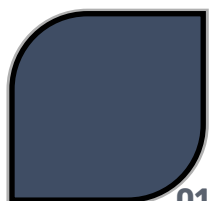

Marino

01



Rojo

05



Negro

13



Náutico

15



Verde Billar

71



Base rígida incluida.

BOLSO MULTIDEPORTE RECTANGULAR Ref. B002



DESCRIPCIÓN

Bolso rectangular multideporte con dos bolsillos laterales independientes.

COMPOSICIÓN

Poliéster 600D

OPCIONES DE PERSONALIZACIÓN

- Bordado
- Serigrafía
- Vinilo termoadhesivo

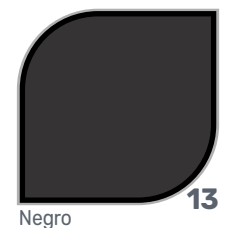
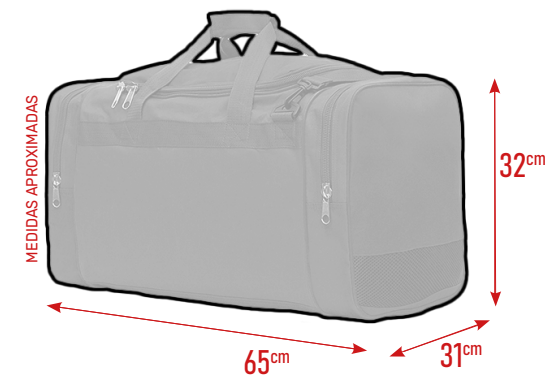

MOCHILA MULTIDEPORTE ZAPATILLERO Ref. B003



DESCRIPCIÓN

Mochila multideporte con zapatillero independiente rígido. Bolsillo frontal e interior.

COMPOSICIÓN

Poliéster 600D

OPCIONES DE PERSONALIZACIÓN

- Bordado
- Serigrafía
- Vinilo termoadhesivo

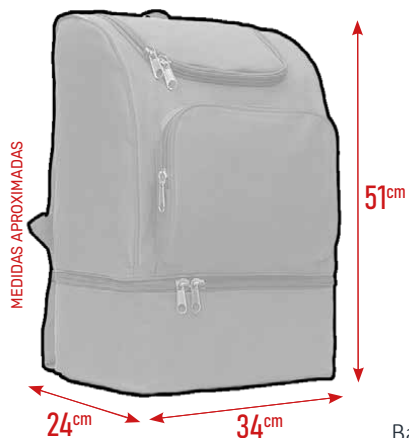

Base rígida incluida.



Marino

01

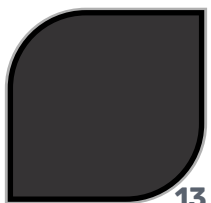

Negro

13



Náutico

15



MOCHILA MULTIDEPORTE NEW Ref. B004



DESCRIPCIÓN

Mochila multideporte. Bolsillo frontal, interior y lateral.

COMPOSICIÓN

Poliéster 600D

OPCIONES DE PERSONALIZACIÓN

- Bordado
- Serigrafía
- Vinilo termoadhesivo

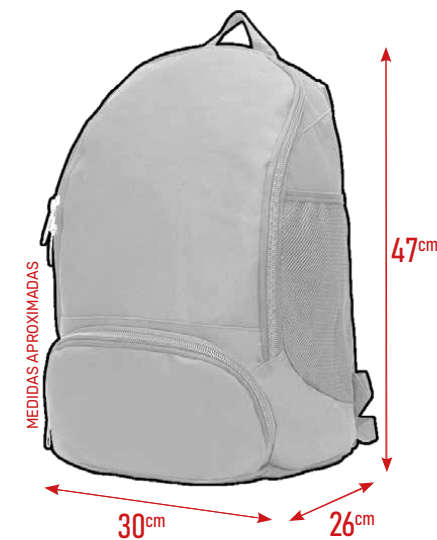

Marino

01

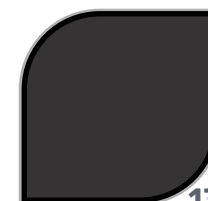

Negro

13

BOLSA GYM Ref. B005

DESCRIPCIÓN

Bolsa con cierre de cordón.

COMPOSICIÓN

Poliéster 600D + 210 AC

OPCIONES DE PERSONALIZACIÓN

- ▶ Bordado
- ▶ Serigrafía
- ▶ Vinilo termoadhesivo

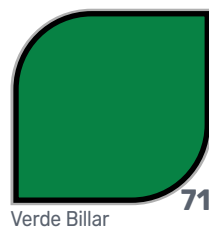
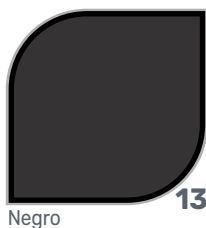
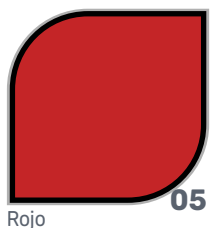
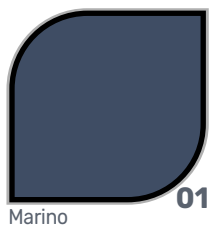

ZAPATILLERO Ref. B006

DESCRIPCIÓN

Bolsa zapatillero con ojeteros para aireación.

COMPOSICIÓN

Poliéster 600D

OPCIONES DE PERSONALIZACIÓN

- ▶ Bordado
- ▶ Serigrafía
- ▶ Vinilo termoadhesivo

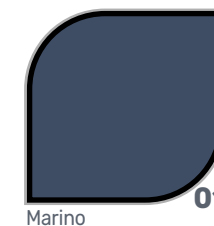
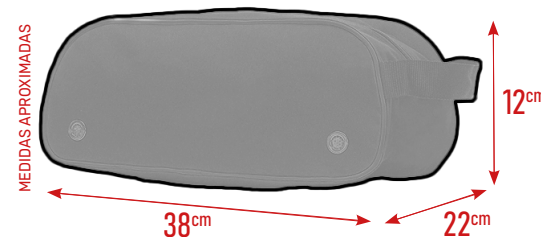

LONAS PUBLICITARIAS

Ref. 209

TEJIDO

Lona blanca mate 510 gr
Ojales de plástico
de 16 mm cada 50 cm



137 cm - medida máxima



25 metros - medida máxima



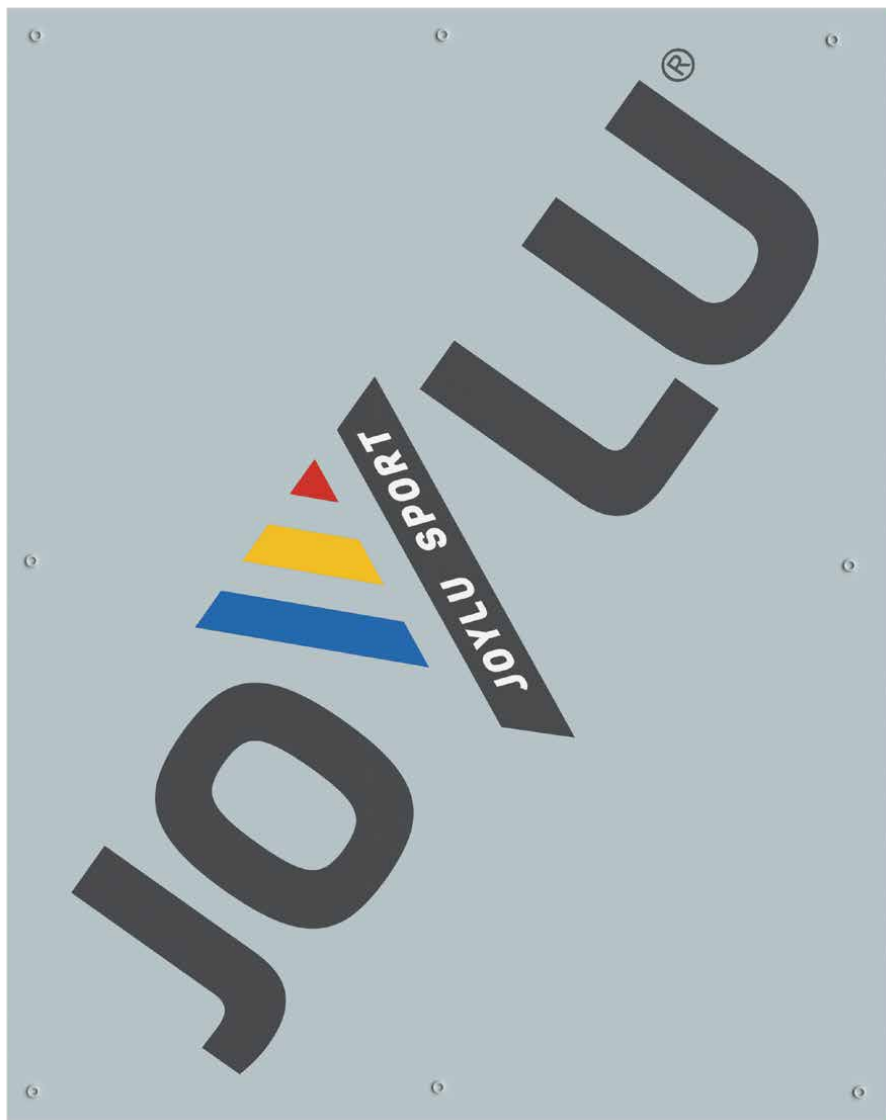

MODELO VERTICAL



MODELOS HORIZONTAL



www.joylu.com

Empresa española fabricante de textil y confección deportiva,
con una amplia gama de productos y acabados con opciones personalizables:
sublimación, serigrafía, bordado, etc.

JOYLU SPORT S.L.

www.joylu.com

957.324.542

info@joylu.com

pedidos@joylu.com

C/ IMPRENTA DE LA ALBORADA, 119F
(POLÍGONO INDUSTRIAL LAS QUEMADAS)
14014 - CÓRDOBA
(ESPAÑA)

Horario:

Lunes a jueves: 09:00 a 18:00 (continuo)

Viernes: 07:30 a 15:00

Julio y agosto:

Lunes a viernes: 07:30 a 15:00



- facebook.com/JoyluSport
- instagram.com/joylu_sport/
- mobile.twitter.com/joylu_sport

Consulte con nuestro departamento comercial las distintas opciones en tejidos, patrones, acabados, y cualquier duda que tenga
Las imágenes de este catálogo están realizadas digitalmente en 3D, pueden no coincidir puntualmente con el modelo original